



USER MANUAL

Thank you for purchasing GRECELL portable power station

To make sure your personal safety, property security and user experience, please read this manual carefully before operating and retain it for future reference.

⚠ CHARGE FIRST!

Before using your new Power Station HW01, plug it into a suitable power outlet until it is fully charged. Then you can start your exciting journey with it. Highly recommend to charge HW01 when battery indicate less than 20%.

■ Feature Details

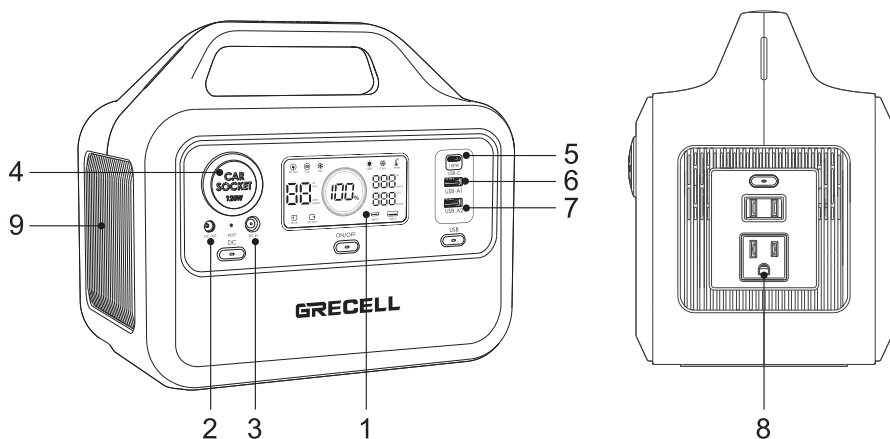

1: LCD Screen Display

2: DC 5521 Output

3: DC Input

4: Cigarette Lighter Output

5: Type-C Output

6: USB-A1 Output

7: USB-A2 Output



8: 300W Rated AC Output

9: Air Intake Vent with Cooling Fan

Note: No user-serviceable parts inside.

Recommended to fully charge the HW01 before use.

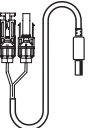
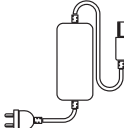
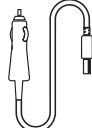
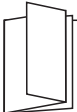
■ HW01 Accessory List

 <p>MC4-7909 Connector Cable</p>	 <p>AC 100-240V Wall Plug Power Adapter</p>	 <p>12V Car Charger Cable</p>	 <p>User Manual</p>	 <p>Cable Storage Bag</p>
---	--	--	--	--

Recommend to use 60/80/100/120W Solar panel (not included).

■ Button Feature

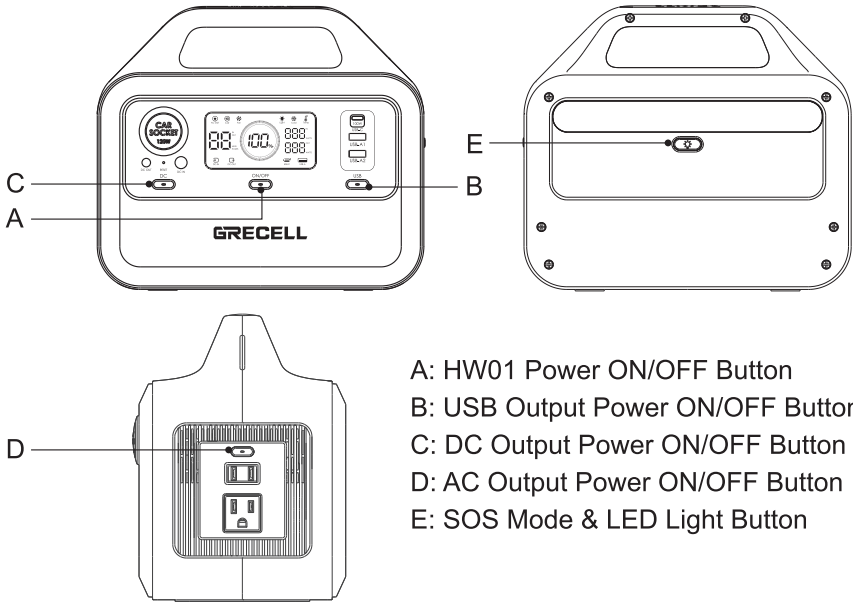

■ Buttons Function

● **Button A: HW01 POWER ON/OFF**

Button A is the master switch. Press button A to turn on the power or to shut down the output(s) when not in use.

● **Button B: USB OUTPUT POWER ON/OFF**

Please make sure the button "POWER ON/OFF" is activated before pressing Button B to turn on; Press button B to shut down the output(s) when not in use. The USB-C cable of different devices needs different endorsements of corresponding protocols, if the USB-C port doesn't work, try to use the AC adapter to charge.

● **Button C: DC OUTPUT POWER ON/OFF**

Please make sure the button "POWER ON/OFF" is activated before pressing Button C to turn on; Press button C to shut down the output(s) when not in use.

● **Button D: AC OUTPUT POWER ON/OFF**

Please make sure the button "POWER ON/OFF" is activated before pressing button D to turn on; Press button D to shut down the output(s) when not in use.

● **Button E: SOS Mode & LED Light Button**

The function is available no matter the button "POWER ON/OFF" is activated or not as the following steps:

Firstly, click the lighting switch to turn on the lighting;

Secondly, click again to switch the lighting mode (Yellow Light-Weak White Light-Strong White Light);
 Thirdly, click again to switch the SOS mode;
 Fourthly, long a press to turn off the lighting.

■ Cooling Fan

HW01 utilizes an internal cooling fan to ensure the product is operating within the appropriate temperature range. HW01, when it experiences a higher output load, will automatically turn on the fan during discharge or recharging, the fan may operate intermittently to keep the internal temperature within operating range.

The fan will likely start when the AC circuit is activated to ensure proper Operation.

■ LCD Features

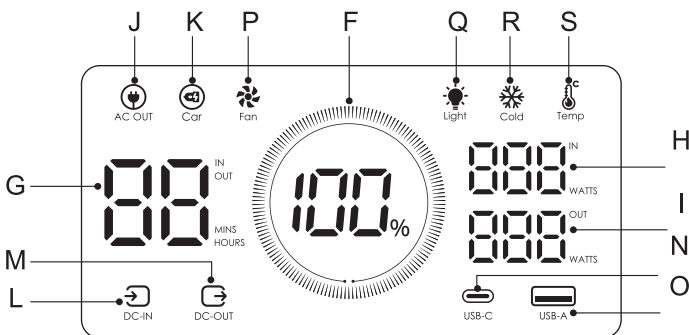

F: Battery Level Indicator

G: Input/Output Time

H: Input Status

I : Output Status

J: AC Output Status

K: Cigarette Lighter Socket Output Status

L: DC Input Status

M: DC Output Status

N: USB-C Input/Output Status

O: USB-A Output Status

P: Cooling Fan Status

Q: SOS Mode & LED Light





















R: Low Temperature Protection

S: High Temperature Protection

Note:

- The LCD screen will enter sleep mode after 5min of inactivity, and will wake up when inputting a charging cord or when any button is pressed.
- When the output power of the device is less than 5W, the device will go into hibernation after more than 8 hours, and the input can be "awakened" when the input is charged or any button is pressed. When not in use, press the switch button to turn off the output.

■ General Specifications

General Specs		
	Rated Capacity	230.4Wh
	Net Weight	about 3.6kg
	Weight(including accessories)	about 4.5kg
	Product Size	244 x 153 x 213mm
Input		
	Recharging Input	11V-24V
	Recharging Input Power	PD 100W+DC 100W, 200W(Max)
	AC/DC Adapter	AC 100-240V(50Hz/60Hz), DC 11V-24V $\overline{=}$ 5A, 100W(Max)
	Solar Charge Input	11V-24V $\overline{=}$ 5A, 100W(Max)
	Type-C Input	5V/9V/12V/15V $\overline{=}$ 3A, 20V $\overline{=}$ 5A, 100W(Max)
Output		
	AC Output	110V-60Hz, 300W(Max)
	Rated Output Power	300W
	Peak Output Power	600W
	Output Waveform	Pure Sine Wave
	Cigarette Lighter Output	10-14.2V, 120W(Max)
	DC Output	10-14.2V, 120W(Max)
	USBA1/A2 Output	4.5V $\overline{=}$ 5A, 5V $\overline{=}$ 4.5A, 5V $\overline{=}$ 3A, 9V $\overline{=}$ 2A
	Type-C Output	5V/9V/12V/15V $\overline{=}$ 3A, 20V $\overline{=}$ 5A
		Total 5V $\overline{=}$ 6A
	LED Lighting	5W Max + SOS
Battery		
	Standard Capacity of Batteries	18Ah,12.8V
	Recharging Temp	32 to 113°F (0 to 45°C)
	Discharging Temp	-4 to 113°F (-20 to 45°C)

■ How to Charge

Note: DO NOT CONNECT DEVICES VIA AC OUTPUT WHILE CHARGING THE HW01.

CHARGING HW01: It is recommended to disconnect the HW01 when fully charged and fully charge HW01 every 3 months to maintain the health of the battery pack.

Do following: Check the input charge cable. The port will be efficient when the input charge cable meets the specification outlined in the GENERAL SPECIFICATIONS section. Note that when you first plug in a power source, whether it's a solar panel or a wall charger, the HW01 may take a minute to detect and adjust its charge circuitry before it starts drawing power from the source.

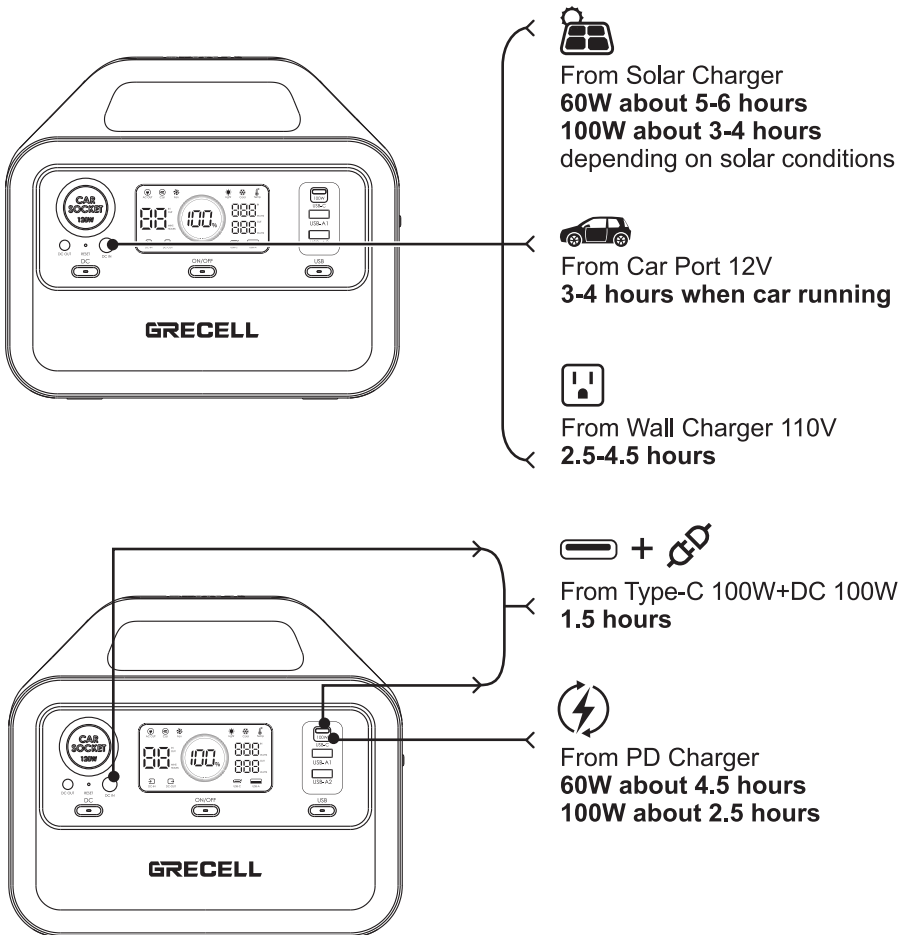

■ Solar Panel Charging

1. DO NOT charge the unit via solar panel that operate voltage outside of DC12-24V.
2. Place Solar Panels in direct sunlight as much as possible.
3. Support 60W/80W/100W/120W max solar panels (not included), the charging time is determined by the solar light intensity.

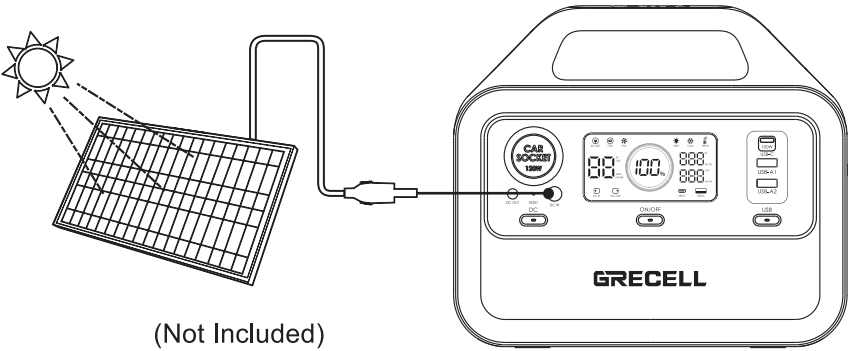

■ Type-C Charging

Input supports PD100W input

1. Input supports PD100W input requires PD60W/100W charger with 100W Type-C cable charge to achieve 60W/100W charging.
2. If using PD60W about 4.5 hours full, using PD100W about 2.5 hours.

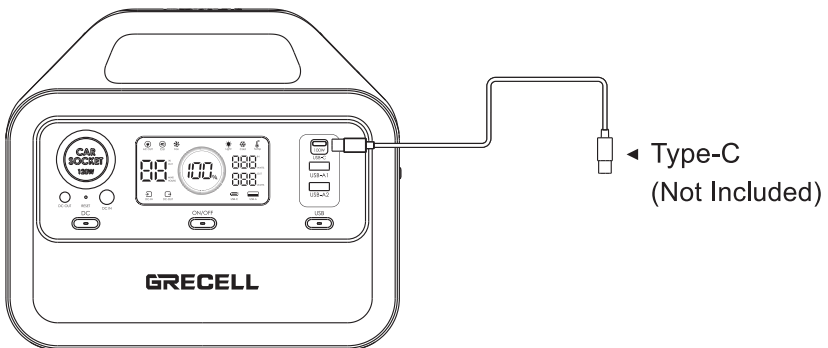

■ AC Adapter Charging

It will take 2.5-4.5 hours to charge fully by using the AC adapter we provided.

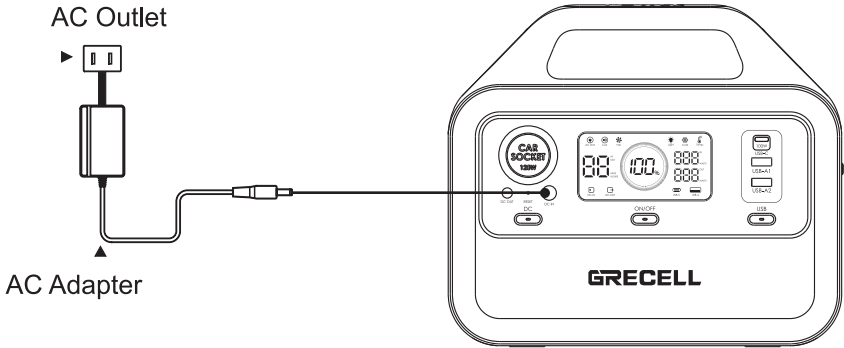

■ 12V Car Charger Charging

Use the car charger we provided to charge this unit. The full charge time takes 3-4 hours. When the LCD display shows the battery power of 100%, it indicates that this unit is fully charged.

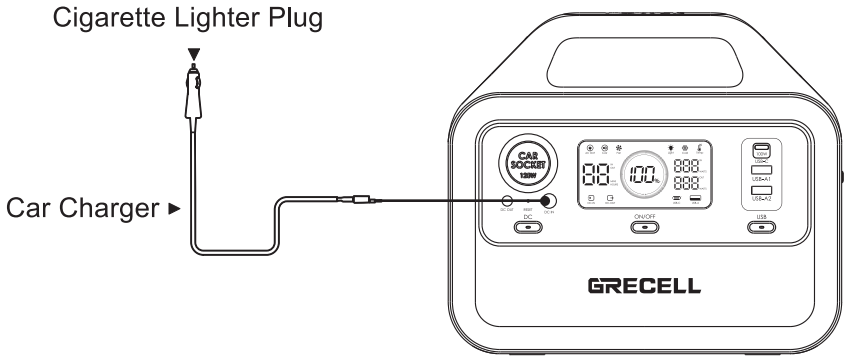

Type-C Charging

4.5 Hours Full

With 60W adapter

2.5 Hours Full

With 100W adapter

DC Charging

4.5 Hours Full

With 60W adapter

2.5 Hours Full

With 100W adapter

Type-C+DC Charging









2.5 Hours Full

With 60W+60W adapter

1.5 Hours Full

With 100W+100W adapter

■ What it Powers

 <p>Laptops (41.4Wh) Around 6 Recharges</p>	 <p>32" TV (60W) Around 4 Hours</p>	 <p>CPAP Without Heated Humidifier (15W) 16 Hours</p>	 <p>Gopro (5.9Wh) Around 42 Recharges</p>	 <p>Floodlight (4W) Around 62 Hours</p>
 <p>Mini Fridge (40W) Around 6 Hours</p>	 <p>Drone (89.2Wh) Around 2.8 Recharges</p>	 <p>Smartphone (10Wh) Around 25 Recharges</p>	 <p>Switch (16Wh) Around 15 Recharges</p>	<p>+MORE</p>

Powering / Charging Devices With HW01:

Select the type of outlet required by pressing the Output ON/OFF Button B/C/D. The output port will NOT function until the appropriate button is pressed to activate the port. When activated, the LCD display will turn on and provide details on the charging output, indicating that the output(s) are active. The LCD Screen will automatically shut down when no outputs are activated.

Pass-through Charging:

The advanced battery management system of the HW01 allows it to charge a connected device via AC output & DC output & USB output while charging the HW01.

Overload Condition:

If an overload condition occurs on the OUTPUT port, HW01 will: Automatically turn off AC Output power. The white indicator light of LCD Screen is still illuminated. DC OUTPUT Status is still the same status as usual.

■ Safety Instructions

Read the following instructions to ensure safety before using. Improper use may result in fire, property damage, or personal injury.



Product Use:

- DO NOT use any inappropriate power cords.
- DO NOT place the unit close to or in a fire or exposing it to heat. Keep out of direct sunlight.
- DO NOT charge, use or store the unit in a bathroom or in an area exposed to rain or moisture. Do not drop the unit into the water. If the battery in the unit comes into contact with water, it may cause chemical decomposition of the battery. This may cause the battery to catch fire or explode.
- Never use or charge swollen, leaky, or damaged batteries. If your battery is abnormal, contact us to get support.
- Never install or remove a battery from the unit when it is turned on.
- DO NOT use the batteries in strong electrostatic or electromagnetic environments. Otherwise, the battery control board may malfunction and cause a serious accident.
- Never disassemble or pierce the product in any way. Otherwise, it may leak, catch on fire, or explode.
- DO NOT use the product if it was involved in a crash or a heavy bump.
- If the product falls into the water during use, take the product out immediately and put it in a safe and open area. Keep a safe distance from it until it is completely dry. Never use it again and dispose of it properly as described in the Battery Disposal section below. If the product catches fire, it is recommended to use fire extinguishing equipment in the following order: water or water mist, sand, fire blanket, dry powder, carbon dioxide fire extinguisher.
- Do Not allow pins, wires, or other metal pieces to insert into the device case, outlets or controls. Metal pieces may short circuit the product.
- Avoid collision. DO NOT place heavy objects on the machine.
- Use and store the unit only in a clean and dry environment. Do not use and store in a dusty and wet environment.
- If there is dirt on any plug or outlet surface, use a dry cloth to clean it. Otherwise, it will cause abrasion and result in energy loss or inability to charge.
- DO NOT put the machine in a microwave oven or in a pressurized container.

Product Recharging:

- DO NOT charge the unit via power supply systems that operate outside of AC120V.
- DO NOT charge the unit via a solar panel that operates voltage outside of DC12-24V.
- Always use approved attachment charging cables. we take no responsibility for any damage caused by using other brand charging cables.
- When charging, please place the product on the ground with no flammable or combustible materials around. To prevent accidents, never leave the machine unattended during charging.
- DO NOT charge a product immediately after a long heavy load, because the product's temperature may be too high. DO NOT charge a product until it cools down to room temperature.
- Only charge, use the unit within an ambient temperature of 0 to 45°C (32 to 113°F). The ideal charging temperature range is 71°F to 82°F (22°C to 28°C).

Equipment Cleaning

Please make sure that the device is disconnected from all input power and output devices. Wipe with a clean, dry, non-soft cotton cloth. Removing any foreign objects, dirt, or other obstructions on the vents on both sides. When cleaning foreign objects in the side vents, do not allow debris, dirt, or other Blockage to enter the equipment.

Do not use corrosive cleaners or solvents.

Do not use compressed air to clean the side cooling vents, as it will cause foreign particles to enter the interior and cause a short circuit.

Note: To avoid the risk of electric shock, do not use metal objects to clean the ports.

Storage

Keep the product out of the reach of children. If any children accidentally swallow parts, please go to a doctor immediately.

If a low-battery warning appears, charge the battery before storing it.

If it will be stored for more than 1 month, please charge it to 50% capacity and keep it indoors, at normal temperature, and the maximum storage time shall not exceed 6 months. please keep away from direct sunlight (see the general specification section).

Store the product in dry environments. DO NOT place the product where it may contact with water.

Excessive temperature will lead to reduced service life, overheating, and fire. Extremely cold conditions below the specified storage range can also impair the performance and service life of the equipment.

Please keep away from corrosive chemicals and gases.

Make sure no small metal objects can fall on or around the product while in storage.

Product Maintenance

Check as needed. Never store the product in environments below -20°C or above 45°C .

Battery life may be reduced if not used for a long time.

If the HW01 energy storage power supply cannot be used regularly, please charge and discharge it every 3 months under normal temperature to keep the service life. Regularly check all ports and wall chargers for any debris, dirt, damage, and corrosion.

Do not disassemble the device privately.

Do not cover the equipment with towels, clothes, or other items. Regularly observe the side vents for dust and foreign matter, and clean them according to the cleaning procedures specified in the manual.

■ **Trouble Shooting**

HW01 does not discharge:

- (1) Checking whether the connecting wire has been inserted in right place;
- (2) Checking whether the total output power exceeds the rated output power;
- (3) Checking whether the temperature of the equipment is too high.

HW01 is not charging:

- (1) Confirming that the AC socket on the wall and the AC charging cable are fully inserted into the AC input terminal;
- (2) Confirming whether the battery pack wiring is in good condition and whether the switch of the battery pack is turned on;
- (3) The device cannot be charged immediately after it is discharged, please put it aside for an hour and try again, it may enter the over-temperature protection.

■ Note

A photovoltaic panel as input for charging the internal battery shall be provided with an inverter and/or a charge controller in accordance with UL 1741 or UL 62109-1; The external power supply shall be a power source in accordance with the Standard UL 60950-1 and CAN/CSA C22.2 No. 60950-1, or UL 1310 and No. 1, CAN/CSA C22.2 No. 223, or No.1, CAN/CSA C22.2 No. 223; A vehicle adapter that complies with the enclosure and input contacts requirements in the Standard for Vehicle Battery Adapters, UL 2089, and Power Supplies, CAN/CSA C22.2 No. 107.1. The connector plug shall incorporate a fuse or other protective device having a current rating not greater than 15 A.

INSTRUCTIONS PERTAINING TO RISK OF FIRE, ELECTRIC SHOCK,
OR INJURY TO PERSONS.

IMPORTANT SAFETY INSTRUCTIONS

1. **WARNING** – When using this product, basic precautions should always be followed, including the following:
 - a) Read all the instructions before using the product.
 - b) To reduce the risk of injury, close supervision is necessary when the product is used near children.
 - c) Do not put fingers or hands into the product.
 - d) Use of an attachment not recommended or sold by power pack manufacturer may result in a risk of fire, electric shock, or injury to persons.
 - e) To reduce the risk of damage to the electric plug and cord, pull the plug rather than the cord when disconnecting the power pack.
 - f) Do not use a battery pack or appliance that is damaged or modified. Damaged or modified batteries may exhibit unpredictable behavior resulting in fire, explosion, or risk of injury.
 - g) Do not operate the power pack with a damaged cord or plug, or a damaged output cable.
 - h) Do not disassemble the power pack, take it to a qualified service person when service or repair is required. Incorrect reassembly may result in a risk of fire or electric shock.
 - i) To reduce the risk of electric shock, unplug the power pack from the outlet before attempting any instructed servicing.
 - j) **WARNING** – RISK OF EXPLOSIVE GASES.
 - 1) To reduce the risk of battery explosion, follow these instructions and those published by the battery manufacturer and manufacturer of any

equipment you intend to use in the vicinity of the battery. Review cautionary marking on these products and on engines.

k) PERSONAL PRECAUTIONS

- 1) Wear complete eye protection and clothing protection. Avoid touching eyes while working near the battery.
- 2) If battery acid contacts skin or clothing, wash immediately with soap and water. If acid enters the eye, immediately flood the eye with running cold water for at least 10 minutes and get medical attention immediately.
- 3) NEVER smoke or allow a spark or flame in the vicinity of the battery or engine.
- 4) Be extra cautious to reduce the risk of dropping a metal tool onto the battery. It might spark or short-circuit battery or other electrical parts that may cause an explosion.
- l) When charging the internal battery, work in a well-ventilated area and do not restrict ventilation in any way.
- m) Under abusive conditions, liquid may be ejected from the battery; avoid contact. If contact accidentally occurs, flush with water. If liquid contacts eyes, additionally seek medical help. Liquid ejected from the battery may cause irritation or burns.
- n) Do not expose a power pack to fire or excessive temperature. Exposure to fire or temperature above 130°C may cause an explosion. The temperature of 130°C can be replaced by the temperature of 265°F.
- o) Have servicing performed by a qualified repair person using only identical replacement parts. This will ensure that the safety of the product is maintained. SAVE THESE INSTRUCTIONS.

■ Disposal/Recycle



Do not put the device and its accessories in the trash can. Items must be properly handled in accordance with local laws and regulations.



Please see www.epa.gov for additional information.

■ **Warranty & Customer Service Support**

Thanks for purchasing our HW01 portable emergency power station.
If you have any questions about it, please feel free to contact us.

All GRECELL products come with a full 2-year limited warranty from the date of purchase (accessories excluded). It will be out of guarantee if damaged due to incorrect use or force majeure.

If you have any questions, please feel free to contact us:
E-mail: support@grecell.com